

MULTIMAT MOTION DETECTOR

INSTRUCTIONS ON USE

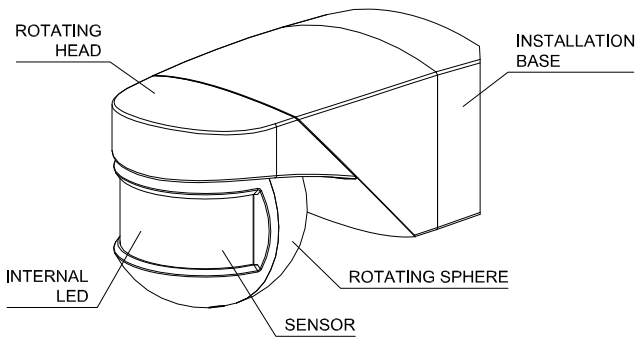

DESCRIPTION

The MULTIMAT detects invisible infrared radiation from people and other heat sources without emitting any form of radiation. When a heat source moves in front of the MULTIMAT, its output circuit is activated and when it no longer detects the movement, it will deactivate after an adjustable delay. The MULTIMAT reacts in this way only when ambient light conditions are below the selected level.

INSTALLATION

WARNING: The assembly and installation of the electric apparatus must only be carried out by an authorised installer. ALL POWER MUST BE SWITCHED OFF PRIOR TO COMMENCING INSTALLATION WORK

The apparatus is fitted with an internal security circuit that protects it against electromagnetic interference. However, certain especially strong magnetic fields could affect its operation and therefore, it must not be installed close to inductive loads (motors, transformers, telephony antennas, transformer substations and industrial machinery etc).

MOUNTING

It can be mounted on walls or ceilings. For ceiling mounting, rotate the head until the sensor is correctly orientated as shown in the following diagram:

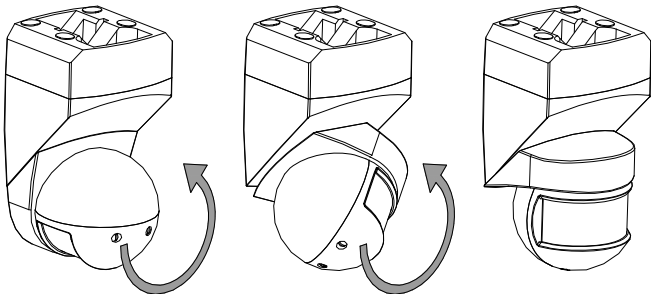

Highly reflective surfaces (liquids and marble, etc.), elements subject to sudden changes in temperature (heating and air-conditioning and possible air currents) and also light sources must be avoided within its detection area.

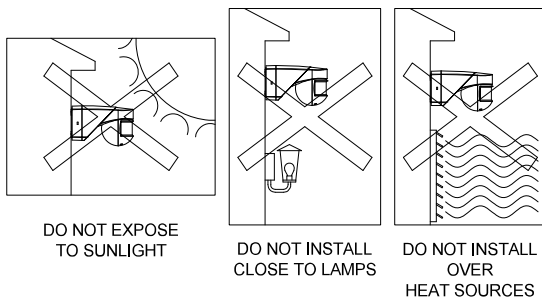

The base has 8 precut holes for flat wall installation. According to the installation type (wall, inner or outer corner) you have to perforate the most appropriate holes.

To install in an inner corner it is necessary to break the weak parts in the installation base.

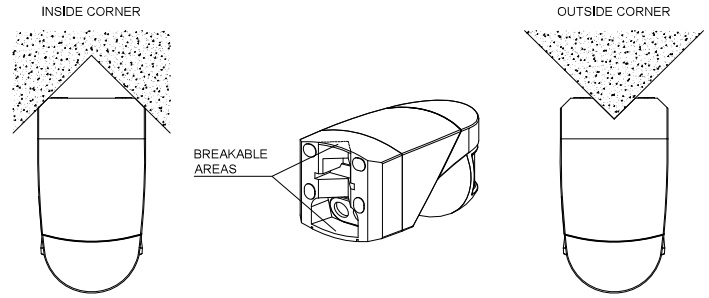

The ideal mounting height is between two and three metres and the direction of movement of possible heat sources should be transversal to the MULTIMAT lens.

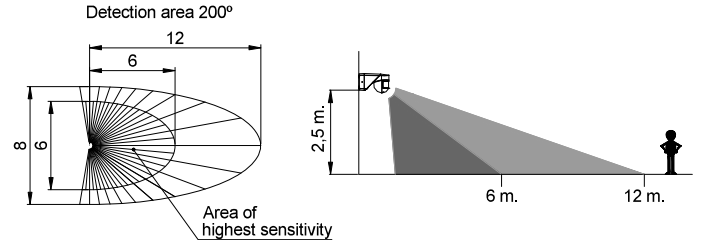

It must be taken into account when installing the MULTIMAT that detection takes place when the detection beams are crossed; therefore, if the heat source to be detected is moving parallel to the beams, detection will be produced at a smaller distance since it will not cross the beams until it is very close to the apparatus.

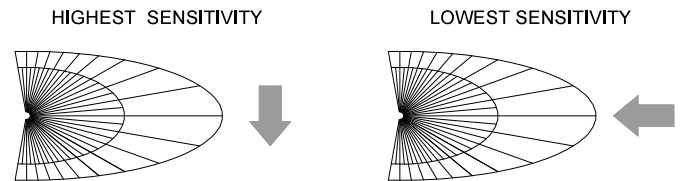

In the above figures, the arrow indicates direction of movement of the person or object to be detected.

The ambient temperature where the MULTIMAT is installed can significantly affect detection sensitivity and hence, the detection distance. Higher temperatures means reduced sensitivity because the apparatus operates by detecting the movement of a heat source (in most cases, this temperature is 36 °C, that of the human body), the closer the ambient temperature is to 36 °C, the poorer the detection.

The securing base includes the electric connections so that it can be installed in its position with the connections already made and then the detector is fitted to the base. Similarly, if the detector has been dismantled, there is no need to dismantle the base.

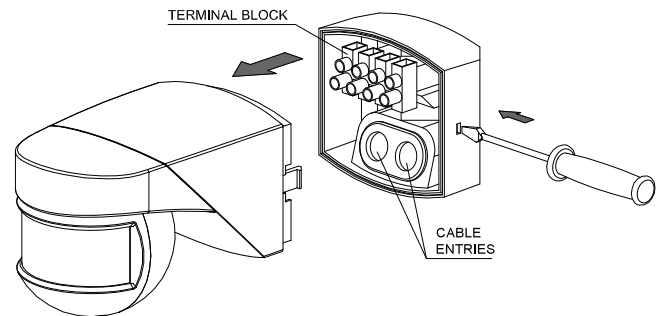

CONNECTION

The unit should be connected in accordance with the following diagram:

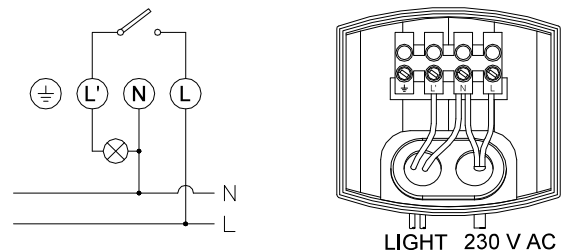

PUTTING INTO OPERATION: ADJUSTMENTS

There are two controls on the MULTIMAT sphere:

DELAY TIME ADJUSTMENT

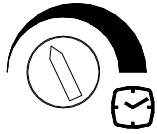

AMBIENT LIGHTING LEVEL ADJUSTMENT

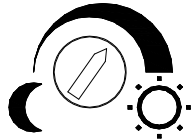

ADJUSTING THE DETECTION FIELD

The head is able to rotate horizontally by approximately 180° (do not attempt to force rotation beyond 180°) and vertically by approximately 45°, thus moving the detection area as shown in the figure:

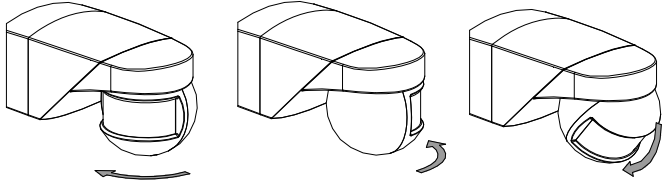

The detection field can be adjusted by following these steps:

- Rotate the switch-off delay adjustment to minimum and the ambient light level adjustment to (☀).
- Check coverage by moving within the detection field limits.

After installation and detection field adjustments, set the ambient light level and switch-off delay as required.

The MULTIMAT is supplied with detection area limiters. Each limiter is divided into four sectors that can be cut according to needs. A sector is excluded by covering the corresponding part of the lens with limiter adapted to the actual requirements.

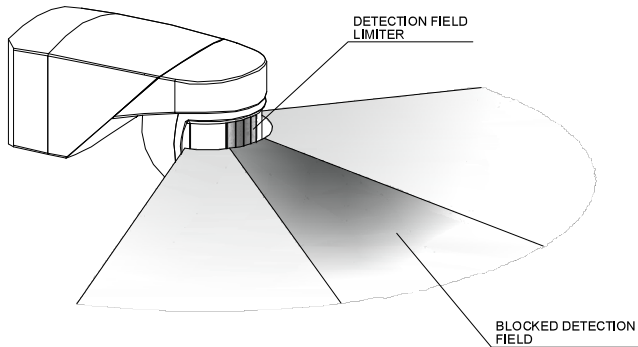

ADJUSTING AMBIENT LIGHT LEVEL

The MULTIMAT can be adjusted so that it only operates when ambient light level conditions are below the selected level. By rotating the ambient light level control to position (☀), it will react under any lighting conditions. Setting it to position (☾) will mean it only reacts under very low ambient light level conditions.

When the ambient light level conditions are those desired for detection operation, rotate the ambient light level control to position (☾). Then rotate it slowly to the right until the illumination comes on. When the MULTIMAT is ready to detect (the ambient light level is below the adjusted value), the internal LED will flash every three seconds.

For the changes made to take effect in the potentiometers in the adjustment of the equipment, it is necessary to get out from the detection area and wait for the installation to be turned off.

ADJUSTING THE SWITCH-OFF DELAY

By rotating the control (⌚), the switch-off delay is as follows:

- Minimum switch-off delay time: 3 seconds
- Maximum switch-off delay time: 30 minutes.

This time is reset for each detection operation.







Detection sensitivity may be reduced if the temperature of the object to be detected is close to the ambient temperature.

When the MULTIMAT delay time ends, there is a two-second period of inactivity during which it does not detect.

OPERATING MODE

- The unit enters normal operation thirty seconds after being switched on.

TECHNICAL SPECIFICATIONS

Power supply	230 V 50 Hz.
Breaking power	μ 10 A 230 V~ cos φ=1
Maximum recommended loads	
 Incandescent lamps	2000 W
 Fluorescent tubes	600 VA
 Low voltage halogen (12 Vac)	600 VA
 Halogen (230 Vac)	2000 W
 Low consumption lamps (CFL)	600 VA
 Low consumption lamps (Downlights)	600 VA
 Led lamps	60 VA
Power consumption	8.5 VA (1.5 W approx.)
Ambient lighting level range	5-30-2000 Lux.
Timer range	from 3 s to 30 min. approx.
Detection angle	200°
Detection field	Front: 12 metres to 20 °C. Lateral: 8 metres to 20 °C.
Operating temperature	-20 °C to +40 °C
Protection type	IP 55 by EN 60529.
Protection class	Class II by EN 60669 under correct installation conditions.

DIMENSIONS

